

GE+ vAC ePlus

Regenerative AC Grid Emulator



GE+ vAC is a 4Q programmable AC Voltage Source designed to create both stable and distorted AC grids, adding now a predefined IEC testing software. This cost-competitive solution is specially suitable to perform AC testing in the fields of: Renewable Energy Sources, Smartgrids, EV and EVSE and, in general, grid connected devices.



Regenerative Technology

Thanks to our bi-directional topology, the AC Grid Emulator Converter are regenerative, resulting in a reduction of both the consumed energy during the tests and the power required from the electrical installation.

This technology allows us to work in both directions, as power generators or offering a consumption for the realization of all types of tests.

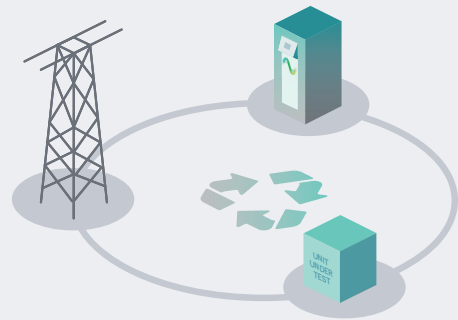

Main Applications



Electromobility



Smart Grids



IEC Testing



Photovoltaic

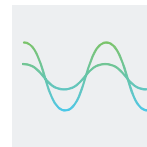

Academical & Industrial Test

Bidirectional and Regenerative

Clean grid current

THDi < 3% and PF > 0.98

13 Models

from 7.5kW to 160kW

Parallelization of units to increase the power

Generation of Worldwide Electrical Grids

3-phase/ 1-phase/ split phase/ Multichannel

Independent Phase Configuration of

voltage rms, phase angle, frequency and harmonics

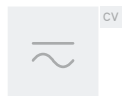
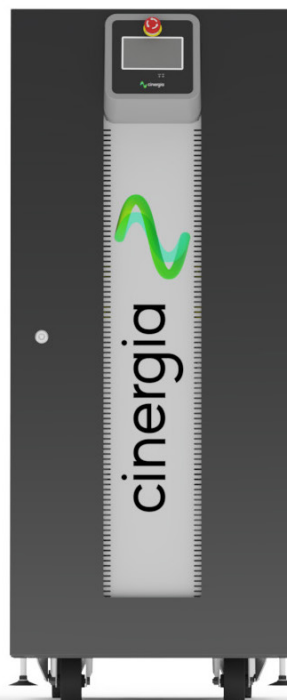

AC

Generation of Disturbances

harmonics, interharmonics, subharmonics, voltage dips frequency variation, flicker

Disturbance Generation Editor

compatible with IEC, LVRT, SEMI-F47, CBEMA test standards

Intuitive User Interface

Modbus/Ethernet Open protocol, Labview drivers

Bidirectional and Regenerative Hardware

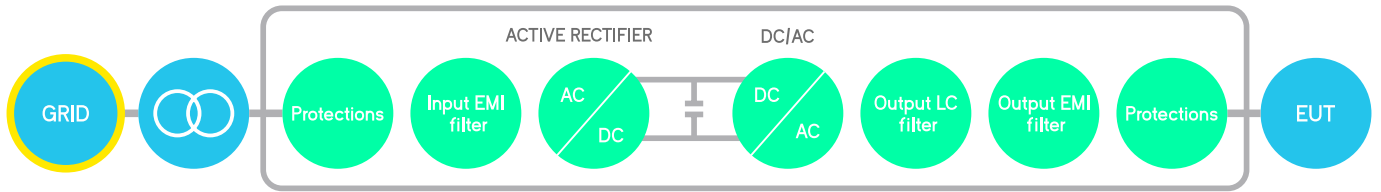

The hardware platform is based on a Back-to-Back power conversion topology, formed by two IGBT-based power stages. The grid side stage is an Active Rectifier which produces clean sinusoidal currents with very low harmonic distortion and power factor close to one.

The EUT side stage can be configured for AC voltage source or AC current source or DC output. In AC, voltage/current are controlled by using state of the art digital Proportional-Resonant controllers. In DC, the three independent buck-boost bidirectional legs enable the separated control of three different DC voltages or currents.

Block Diagram

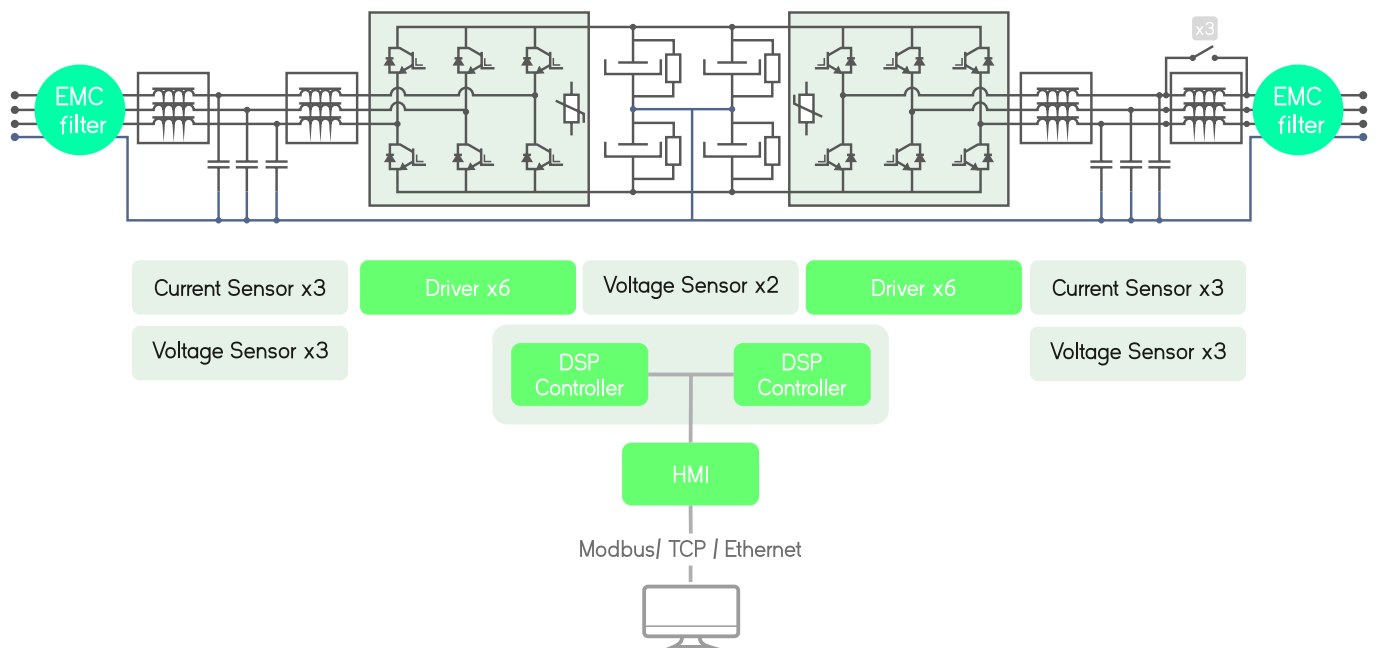

Local Interface

Analogue and Digital 10 ports

The isolated digital and analogue inputs/outputs permit the connection of the unit to External Controllers and Power Hardware in the Loop systems (option).

4.3" Touchscreen

Allows the local parameterization and command of the device, configuration of the communications link, plots the main signals and enables the local datalogging.

Safety First

The units integrate a local Emergency Stop pushbutton and two signals (input+ output) to be connected to the laboratory interlock system. Additionally, the digital outputs can be interfaced to safety tower lights.

Master/Slave

ePLUS is a modular platform enabling the master/slave connection of units with equal power.



Better than ever, the enhanced **Plus** family



What's better

MASTER/SLAVE CONNECTION

by using a fiber optics link to increase power/voltage capabilities:

GE in AC: can be connected in parallel

EL in AC: can be connected in parallel

B2C: can be connected in parallel, or series or both

FASTER

30kHz control loop frequency

MORE HARMONICS

50 per phase with 20 free-harmonics

DELTA LOAD

for the EL in AC mode

ADJUSTABLE DC TRANSIENT

controllers to improve stability of the system

OPTIMIZED RMS CALCULATION

for PV inverters anti-islanding test

SAME ELECTRICAL RATINGS

and SAME BANDWIDTH

because the power platform does not change so robustness and ratings remain the same.

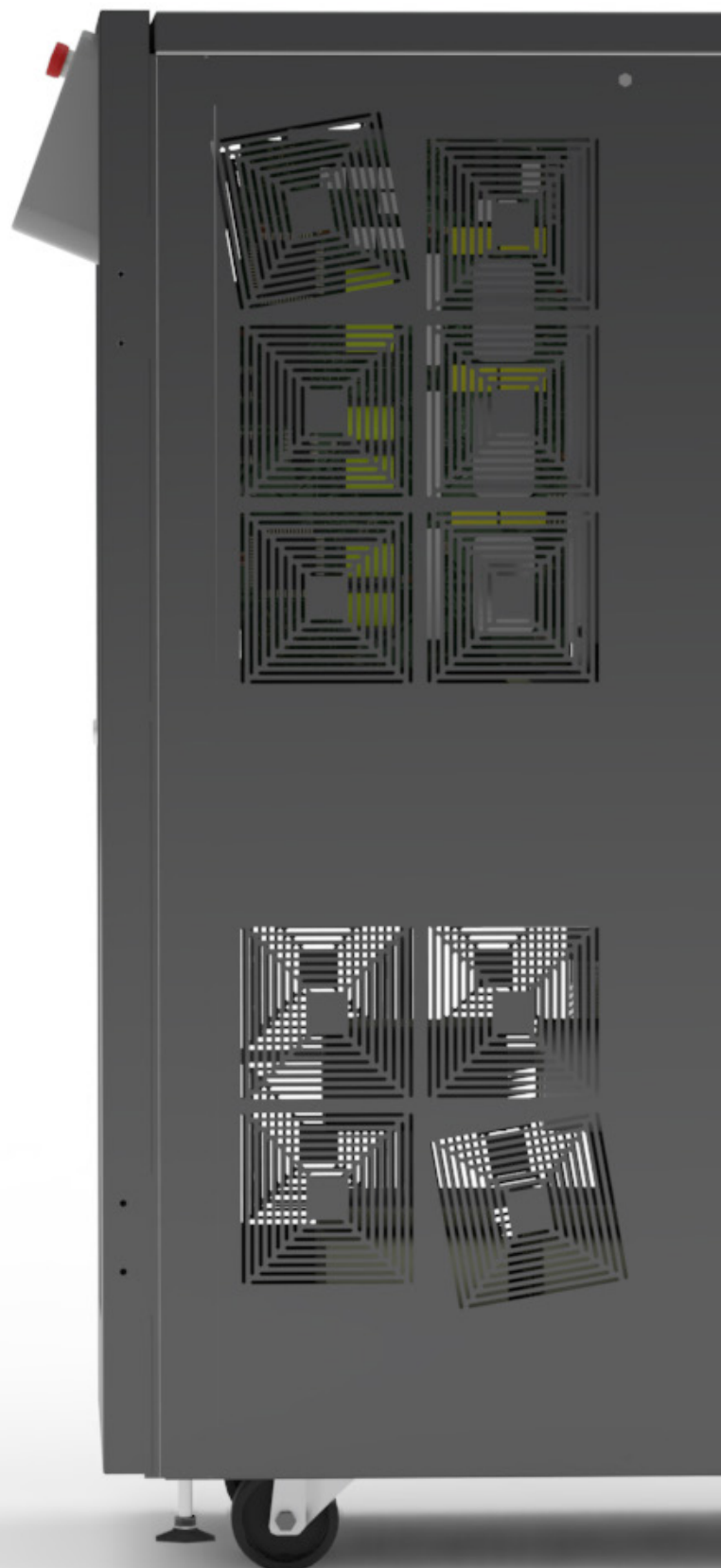

Software



The user interface used by CINERGIA devices has been developed by our R&D team, to offer total control of the device, with a comfortable and intuitive design. This allows us to take full advantage of the capabilities of the device, as well as the programming and execution of standardized or self-created tests.

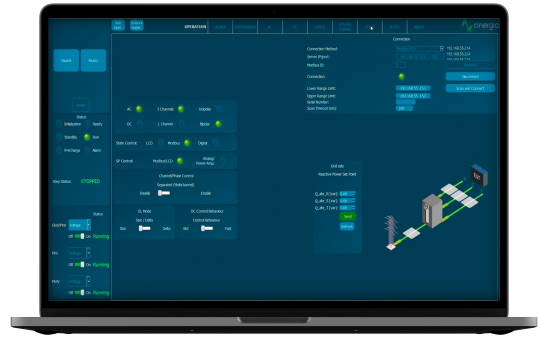

GE Modes



AC Operation

From this panel, the user can set all AC parameters. Each phase can be independently configured: RMS current magnitude, phase delay, harmonics content, free-frequency harmonic and transition ramps. A plot shows the expected real-time waveform, the FFT representation and the numeric data: RMS, peak, CF and THD.



Harmonics

The device can control simultaneously the magnitude of the first 15 harmonics and one free harmonic per phase. The free one allows the generation of sub-harmonics, inter-harmonics and high frequency harmonics up to the 50th, setting both the magnitude and phase delay.

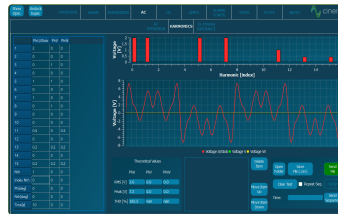

Parallel Mode

The device can be controlled in parallel mode where all phases are short-circuited internally. This mode it's suitable for single-phase applications. To increase the total power of the solution, the device can be connected in parallel* with multiple devices.

*For this connection contact us.

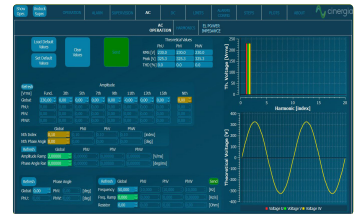

AC



Steps Mode

One of the most remarkable novelties of the new software is the steps functionality. Step test files are saved and executed by the DSP allowing deterministic timing with a resolution of 66µs. The user gains access to all registers of the device to create complex test sequences which run directly in the converter without the need of an external computer.

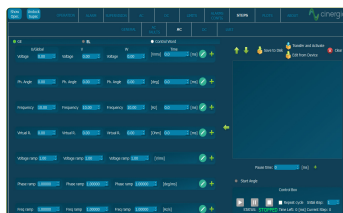

Disturbance Generation

The steps mode includes predefined easy-to-use test panels. The AC faults panel is a powerful yet intuitive editor which allows generating and configuring flicker. Specific profiles can be saved in .csv files, modified, and reused by importing an existing one.

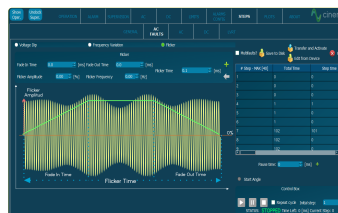

IEC Testing

Optional

The last version of software includes a library supporting IEC standard for pre-compliance tests. The profiles defined in the standards are preloaded in the software for a user friendly execution and edition. Currently the following standards are available:

- IEC61000-4/11
- IEC61000-4/14
- IEC61000-4/13
- IEC61000-4/28

*It is mainly intended for pre-compliance testing. Contact us for further information.



GE+ vAC/DC Range & Specifications

Input side (GRID side)

AC Voltage

Rated: 3x400Vrms +Neutral+ Earth
Range: +15% / -20%

Rated AC Current

Depends on model (see Wiring Manual)

Frequency

48-62Hz

Current Harmonic Distortion

THDi < 3% at rated power

Current Power Factor

PF > 0.98 at rated power

Efficiency

≥ 89% (7.5 & 10), ≥ 91% (15 to 30), ≥ 92% (40 to 200)

Output side in AC (EUT side)

Terminals

Number: 4 (3 phases + 1 neutral)

Configuration of Channels

3 channels: 4Q, independent setpoints per phase
1 channel: 4Q, global setpoints for all phases (only in GE+)
Multichannel: 4Q, independent start/stop, alarm status and setpoints per phase (note: multichannel is an option for ≥ 80kVA)

Output side in GE-AC

Voltage Mode (CV)

Peak: ± 400V phase-neutral
Range: 0⁽¹⁾ to 277Vrms phase-neutral (295Vrms with HV option)
0⁽¹⁾ to 480Vrms phase-phase (510Vrms with HV option)
THDv: < 0.1% rated linear load at 230Vrms, 50/60Hz
< 0.9% rated non linear load CF=3 at 230Vrms, 50/60Hz
Setpoint Resolution: 10mVrms
Effective Resolution⁽²⁾: < 0.05% of FS⁽³⁾
Setpoint Accuracy⁽⁴⁾: < ± 0.1% of FS⁽³⁾
Transient Time⁽⁵⁾: < 1.5ms (10% to 90% at a step to V_{rated})
Ripple⁽⁷⁾ (peak-peak): < 0.55% of FS⁽³⁾

Enhanced

Harmonics

Range: up to 50th (at 50/60 Hz fundamental)
50 independent harmonics per phase:
20 free programmable frequency and phase from 0.1 to 50 times f₀
30 fixed frequency
Harmonics content: V·f < 46000 (with current derating)
Setpoint Accuracy⁽⁴⁾: same as voltage accuracy
Small Signal Bandwidth: up to 5000Hz⁽⁹⁾
Transient Time⁽⁵⁾: < 2ms (10% to 90% at a step change)

Frequency

Fundamental Frequency Range: 10 to 100Hz (up to 400Hz option)
Small Signal Bandwidth: up to 5000Hz⁽⁹⁾
Resolution: 1mHz

Phase Angle

Range: 0 to 360°
Resolution: 0.01°

Operation Modes

AC

Programmable Voltage (CV) (only in GE+)
Steps
LVRT, IEC 61000 -4-11, 4-13, 4-14, 4-28

Optional

Overload/ Overcurrent

Admissible AC overcurrent: 125% of rated value during 10 minutes,
150% during 1 minute, 200% during 2 seconds
Admissible overloads: 125% of rated value during 10 minutes,
150% during 1 minute, 200% during 2 seconds

User Interface

Local Control (4.3" Touchscreen panel)

Isolated Digital port: 6 inputs, 4 outputs
Isolated Analogue port: 6 inputs (rms setpoints or power amplifier), 6
outputs (rms readback or real-time readback)
Interlock port: 1 NC Input, 1 NO Output
Emergency Stop pushbutton

Emergency Stop
pushbutton

Touchscreen panel

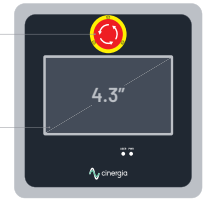

Remote Control Port

LAN Ethernet with Open Modbus-TCP protocol
RS485 (option), CAN and RS232 (using external gateway)

Software

Graphical User Interface for Windows 7/10
LabView drivers and open Labview interface example

Enhanced

Master/Slave Operation

Connection: fiber optics link (x6)
Configuration: from software user interface/MODBUS up to 8 units:
AC: Parallel

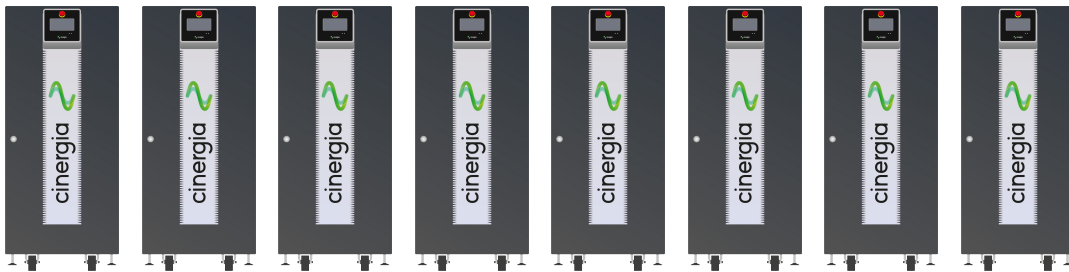

Size and Weight

Models 7.5 to 60 kW

Height

1100 mm

Width

450 mm

Depth

770 mm

Weight

200 kg

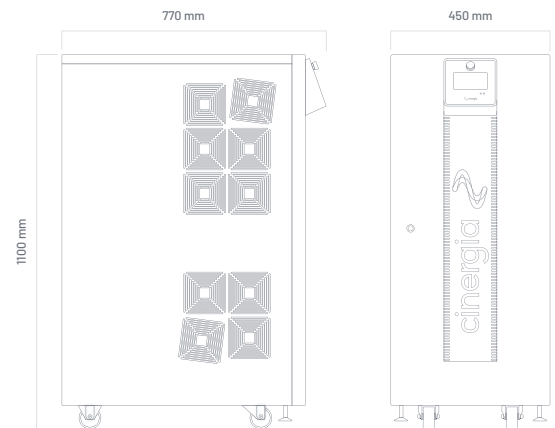

Models 80 to 120 kW

Height

1320 mm

Width

590 mm

Depth

870 mm

Weight

320 kg

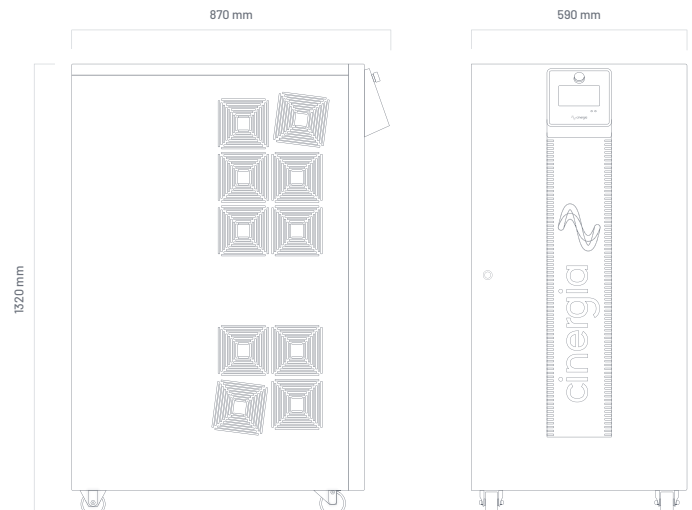

Models 160 & 200 kW

Height

2000 mm

Width

900 mm

Depth

850 mm

Weight

680 kg

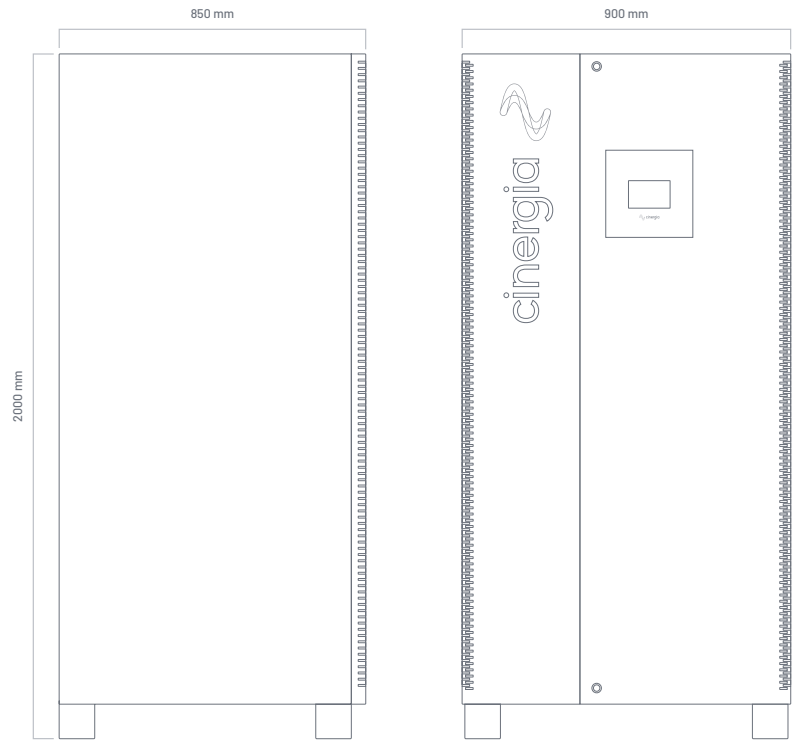

Connections

Fiber Optics

Digital IO

EPO EPO Output

Analogue IO

Internal Comms

Modbus

CAN Out

RS323 / RS485

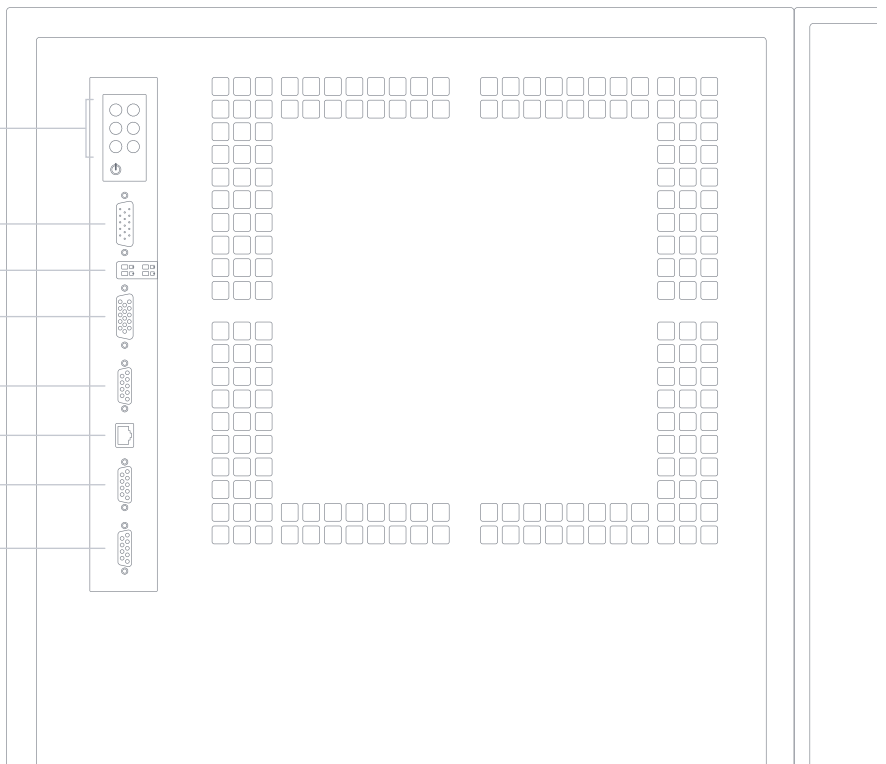

The distribution of the connectors may change depending on the models

Selectors

Output EUT SIDE

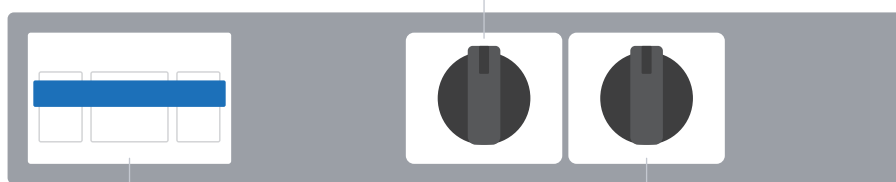

AC Input GRID SIDE

1 Channel / 3 Channel Mode

The type of selectors and their location may change depending on the models

Protections

Overvoltage (peak, rms), Overcurrent (peak, rms), Overload
Shortcircuit, Emergency Stop, Watchdog, Heart Beat, Output
Contactar, Wrong Configuration
Alarms and Limits are user configurable and can be saved in a
password protected EEPROM

Mesurements ⁽⁶⁾

Grid Voltage (rms), Current (rms), Power (P,O) and Frequency
Output Voltage (rms, avg), Current (rms, avg), Power (P,O) and Frequency
Heatsink Temperatures (x2) and DC Link Voltage
Datalogging available through FTP connection

Ambient

Operating temperature⁽⁶⁾ : 5-40°C
Relative Humidity: up to 95%, non-condensing
Cooling: Forced air
Acoustic noise at 1m: < 52dB(A)(7.5 to 60), < 65dB(A)(80 to 120), < 70dB(A)(160 and 200)

Standards

CE Marking
Operation and Safety: EN-50178, EN-62040-1
EMC: EN-62040-2
RoHS

All specifications are subject to change without notice.

Options

Choose your options:

- Galvanic Isolation
- Three channel mode: allows different operation mode start/stop/reset per channel (included in all models from 7.5 to 60, both included)
- 30kHz Switching Frequency: only available for models 15 (derated to 7.5kW), 20 (derated to 7.5kW) and 30 (derated to 10kW)
- Isolation monitor (advised for IT systems)
- Low voltage ripple capacitance
- High Frequency 360 - 900 Hz
- Anti-islanding monitor (only advised in net injection to the grid and following local regulations)
- High Voltage (HV): voltage up to 295Vrms phase-neutral in AC up to 800V in DC
- RS485
- Predefined Tests: LVRT, IEC 61000-4-11, 4-13, 4-14, 4-28 (consult us for specific Test)
- External gateway for RS232, CAN and others (consult us for specific gateway)

All specifications are subject to change without notice.

1. Minimum voltage setpoint is 0V in DC. The recommended minimum setpoint for long-term use is 20Vrms in AC and 20V in DC,
2. Effective resolution measured with a 400ms window
3. FS Range of voltage is 800V (with High Voltage option)
FS Range of current is 2-13 · I rated I (see models table)
FS Range of power is 2-1200% · Prated I (see models table)
4. Accuracies are valid for settings above 10% of FS
5. Measured with the rated resistive load and high-dynamics controllers configuration.
6. Accuracy of measurements is ±0.1% of FS for rms voltage, ±0.2% of FS for rms current, ±0.4% of FS for active power (valid only above 10% of FS)
7. Consult us for lower voltage/current ripple requirements
8. Rated power figures are given at 20°C
9. The maximum output voltage depends on frequency following $V \cdot f < 46000$

Models

GE+ vAC

Reference	AC Power Rated ⁽⁹⁾	AC Current Rated ⁽⁹⁾ RMS 3 channels / 1 channel	DC Power Rated ⁽⁹⁾	DC Current Rated ⁽⁹⁾ RMS 3 channels / 1 channel	Weight (kg)	Dimensions DxWxH (mm)
GE+ 7.5 vAC	7.5 kW	11 A / 33A	-	-	155 kg	770 x 450 x 1100 mm
GE+ 10 vAC	10 kW	15 A / 45 A	-	-	155 kg	770 x 450 x 1100 mm
GE+ 15 vAC	15 kW	22 A / 66 A	-	-	155 kg	770 x 450 x 1100 mm
GE+ 20 vAC	20 kW	29 A / 87 A	-	-	155 kg	770 x 450 x 1100 mm
GE+ 30 vAC	27 kW	40 A / 120 A	-	-	155 kg	770 x 450 x 1100 mm
GE+ 40 vAC	40 kW	58 A / 174 A	-	-	200 kg	770 x 450 x 1100 mm
GE+ 50 vAC	50 kW	73 A / 219 A	-	-	200 kg	770 x 450 x 1100 mm
GE+ 60 vAC	54 kW	80 A / 240 A	-	-	200 kg	770 x 450 x 1100 mm
GE+ 80 vAC	80 kW	116 A / -	-	-	320 kg	870 x 590 x 1320 mm
GE+ 100 vAC	100 kW	145 A / -	-	-	320 kg	870 x 590 x 1320 mm
GE+ 120 vAC	108 kW	157 A / -	-	-	320 kg	870 x 590 x 1320 mm
GE+ 160 vAC	145 kW	211 A / -	-	-	680 kg	850 x 900 x 2000 mm
GE+ 200 vAC	160 kW	232 A / -	-	-	680 kg	850 x 900 x 2000 mm

All specifications are subject to change without notice.

Galvanic Isolation (optional)

	Circuit Breaker Recommended	Weight	
Inside the cabinet	IT 7.5i	Type C - 25 A	145 kg
	IT 10i	Type C - 25 A	145 kg
	IT 15i	Type C - 32 A	145 kg
	IT 20i	Type C - 40 A	145 kg
	IT 30i	Type C - 50 A	195 kg
	IT 40i*	Type C - 63 A	195 kg
	IT 50i*	Type C - 83 A	195 kg

*In the IT 40i and IT 50i models the size of the cabinet increases to a total of 770 x 835 x 1100 mm. The others keep the original size.

	Circuit Breaker Recommended	Weight	Dimensions D x W x H	
In external cabinet IP20	IT 30e	Type D - 80 A	174 kg	595 x 415 x 708 mm
	IT 40e	Type D - 100 A	217 kg	725 x 525 x 773 mm
	IT 50e	Type D - 125 A	280 kg	725 x 525 x 773 mm
	IT 60e	Type D - 160 A	381 kg	875 x 600 x 900 mm
	IT 80e	Type D - 200 A	435 kg	875 x 600 x 900 mm
	IT 100e	Type D - 250 A	458 kg	875 x 600 x 900 mm
	IT 120e	Type D - 315 A	514 kg	875 x 600 x 900 mm
	IT 160e	Type D - 400 A	612 kg	964 x 648 x 1252 mm
IT 200e	Type D - 500 A	753 kg	1192 x 744 x 1430 mm	

Configuration Modes

GE+ AC

Master / Slave

Parallel

in AC modes (GE & EL)

Channel Configuration in GE

3 channels

* 1 channel

*1-channel mode available in standard units up to 60kVA. Consult us for parallel mode above 60kVA.

Regenerative Power Electronic Solutions



Can Baletes 7, Nau A
08310 Argentona
Barcelona (Spain)
+34 934 864 358
info@cinergia.coop

Follow us on:
Youtube, LinkedIn, Twitter