

# EL+ vAC ePlus

Regenerative AC Electronic Load



EL+ vAC is a 4Q programmable AC Current Source designed to emulate the electrical behaviour of passive and active devices connected to the grid. This cost-effective solution is specially suitable for testing AC sources, UPS and EV Charging Infrastructure. Its Regenerative Hardware allows a reduction in the total power and energy needed for the test.



## Regenerative Technology

Thanks to our bi-directional topology, the AC Electronic Load Converter are regenerative, resulting in a reduction of both the consumed energy during the tests and the power required from the electrical installation.

This technology allows us to work in both directions, as power generators or offering a consumption for the realization of all types of tests.

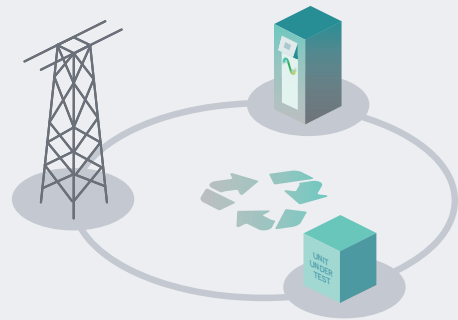

## Main Applications



Electromobility



Smart Grids



Avionics

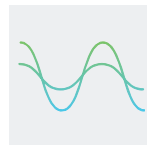

Academical & Industrial Test

## Bidirectional and Regenerative

### Clean grid current

THDi <3% and PF > 0.98

### 13 Models

from 7.5kW to 160kW

### Parallelization of units to increase the power

### Independent phase configuration of

rms current, phase angle, harmonics, interharmonics, generation of fast transients ("Current Dips")

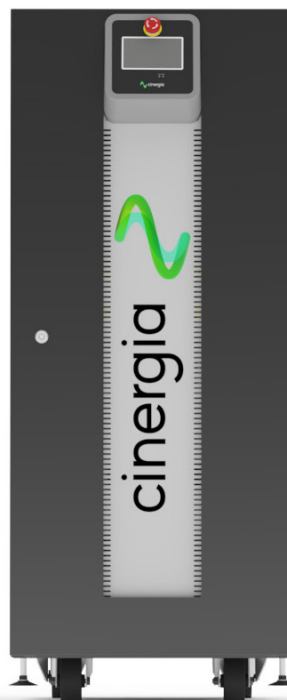

AC

## Overload of 200% P<sub>rated</sub>

### Emulation of grid connected devices

Loads absorbing energy from grid  
Generators injecting energy to the grid  
Programmable Active/Reactive consumption  
Non-linear currents up to CF of 3

### Modbus/Ethernet Open protocol, Labview drivers

# Bidirectional and Regenerative Hardware

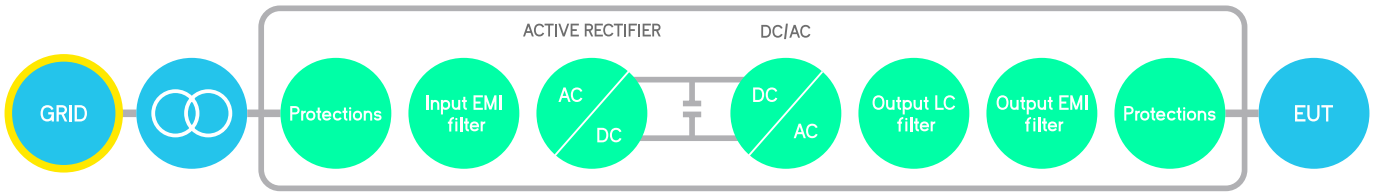

The hardware platform is based on a Back-to-Back power conversion topology, formed by two IGBT-based power stages. The grid side stage is an Active Rectifier which produces clean sinusoidal currents with very low harmonic distortion and power factor close to one.

The EUT side stage can be configured for AC voltage source or AC current source or DC output. In AC, voltage/current are controlled by using state of the art digital Proportional-Resonant controllers. In DC, the three independent buck-boost bidirectional legs enable the separated control of three different DC voltages or currents.

## Block Diagram

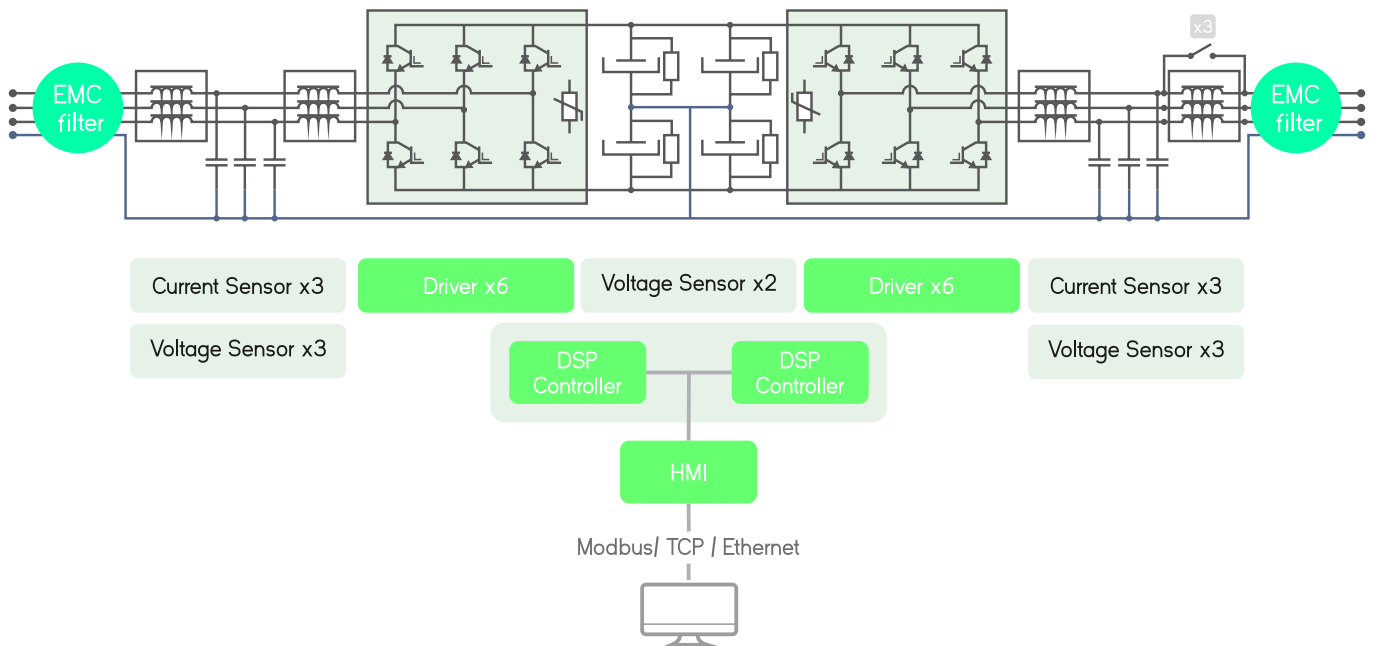

## Local Interface

### Analogue and Digital IO ports

The isolated digital and analogue inputs/outputs permit the connection of the unit to External Controllers and Power Hardware in the Loop systems (option).

### 4.3" Touchscreen

Allows the local parameterization and command of the device, configuration of the communications link, plots the main signals and enables the local datalogging.

### Safety First

The units integrate a local Emergency Stop pushbutton and two signals (input+ output) to be connected to the laboratory interlock system. Additionally, the digital outputs can be interfaced to safety tower lights.

### Master/Slave

ePLUS is a modular platform enabling the master/slave connection of units with equal power.



# Better than ever, the enhanced **Plus** family



## What's better

### MASTER/SLAVE CONNECTION

by using a fiber optics link to increase power/voltage capabilities:

GE in AC: can be connected in parallel

EL in AC: can be connected in parallel

B2C: can be connected in parallel, or series or both

### FASTER

30kHz control loop frequency

### MORE HARMONICS

50 per phase with 20 free-harmonics

### DELTA LOAD

for the EL in AC mode

### ADJUSTABLE DC TRANSIENT

controllers to improve stability of the system

### OPTIMIZED RMS CALCULATION

for PV inverters anti-islanding test

### SAME ELECTRICAL RATINGS

#### and SAME BANDWIDTH

because the power platform does not change so robustness and ratings remain the same.

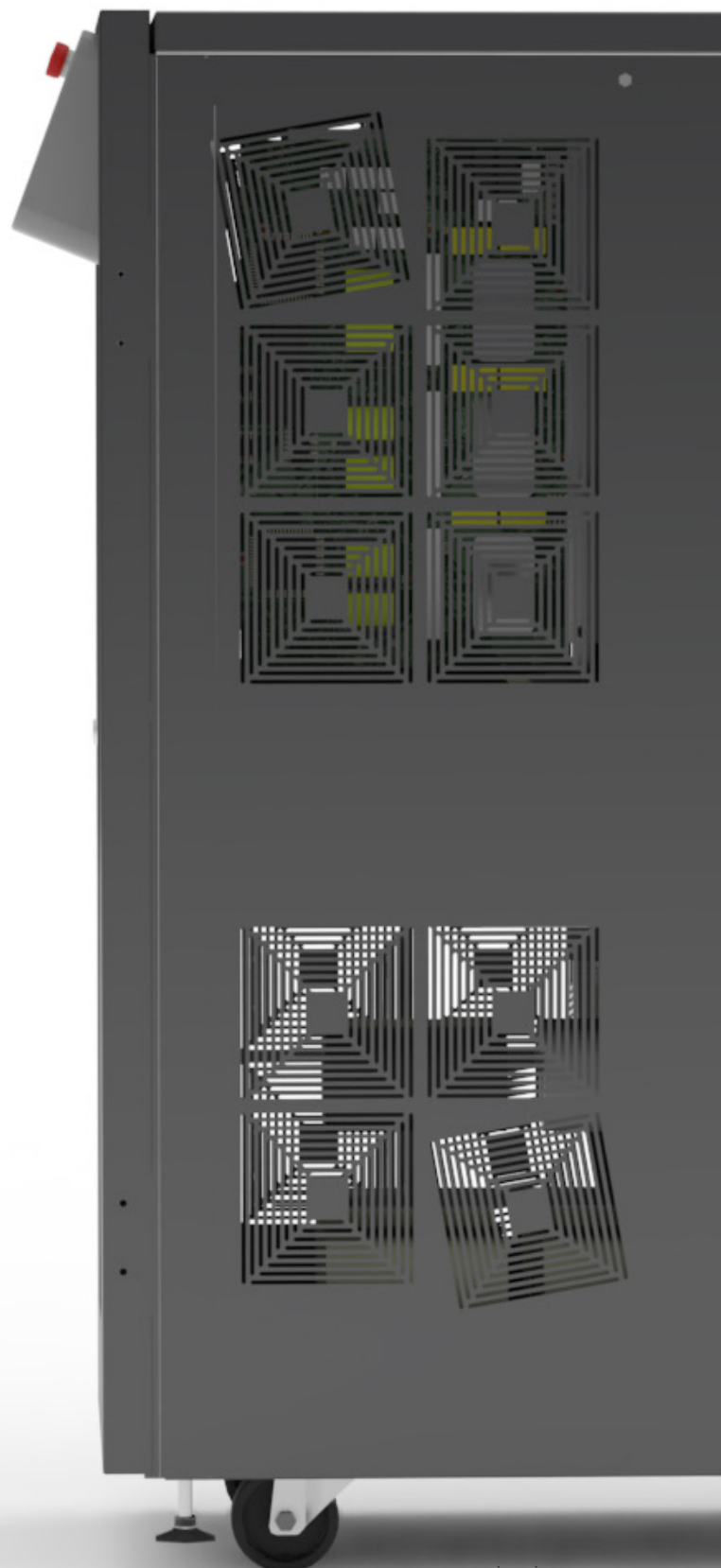

# Software



The user interface used by CINERGIA devices has been developed by our R&D team, to offer total control of the device, with a comfortable and intuitive design. This allows us to take full advantage of the capabilities of the device, as well as the programming and execution of standardized or self-created tests.

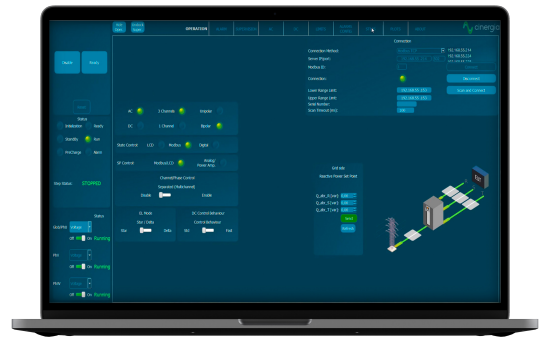

## EL Modes



### AC Operation

From this panel, the user can set all AC parameters. Each phase can be independently configured: RMS current magnitude, phase delay, harmonics content, free-frequency harmonic and transition ramps. A plot shows the expected real-time waveform, the FFT representation and the numeric data: RMS, peak, CF and THD.



### Harmonics

The device can control simultaneously the magnitude of the first 15 harmonics and one free harmonic per phase. The free one allows the generation of sub-harmonics, inter-harmonics and high frequency harmonics up to the 50th, setting both the magnitude and phase delay.



### Power and Impedance Control

In Power mode, the active and reactive power of each phase is independently controlled. In Impedance mode, the device emulates an RLC load allowing to parameterize resistance, inductance and capacitance per phase making this device suitable for Anti-Islanding test of grid converters.

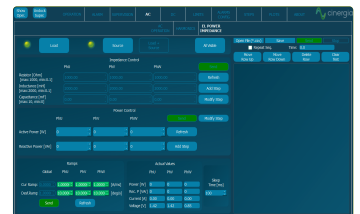

## AC



### Steps Mode

One of the most remarkable novelties of the new software is the steps functionality. Step test files are saved and executed by the DSP allowing deterministic timing with a resolution of 66µs. The user gains access to all registers of the device to create complex test sequences which run directly in the converter without the need of an external computer.

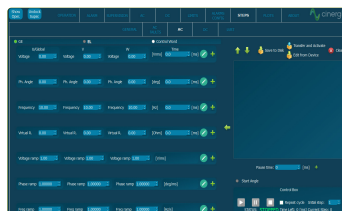

### Disturbance Generation

The steps mode includes predefined easy-to-use test panels. The AC faults panel is a powerful yet intuitive editor which allows generating and configuring flicker. Specific profiles can be saved in .csv files, modified, and reused by importing an existing one.

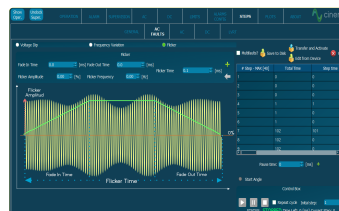

### Linear & Non-Linear Emulation

The capacity to emulate linear and non-linear loads in one of the main features of the 4Q Electronic Load. Through our intuitive control software, the magnitude of harmonics can be set and different types of loads can be generated.

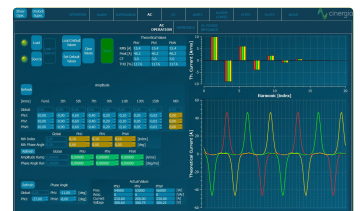

# EL+ vAC Range & Specifications

---

## Input side (GRID side)

### AC Voltage

Rated: 3x400Vrms +Neutral+ Earth  
Range: +15% / -20% (-10% @ P<sub>rated</sub>)

### Rated AC Current

Depends on model (see Wiring Manual)

### Frequency

48-62Hz

### Current Harmonic Distortion

THDi < 3% at rated power

### Current Power Factor

PF > 0.98 at rated power

### Efficiency

≥ 89% (7.5 & 10), ≥ 91% (15 to 30), ≥ 92% (40 to 200)

---

## Output side in AC (EUT side)

### Terminals

Number: 4 (3 phases + 1 neutral)

### Configuration of Channels

3 channels: 4Q, independent setpoints per phase  
Multichannel: 4Q, independent start/stop, alarm status and setpoints per phase (note: multichannel is an option for ≥ 80kVA)

---

## Output side in EL-AC

### Admissible Voltage

Connection: 1-phase, 3-phase star or 3-phase delta  
Maximum: ± 400V peak  
Range: 10-100Hz  
35<sup>(1)</sup> to 277Vrms phase-neutral (295Vrms with HV option)  
35<sup>(1)</sup> to 480Vrms phase-phase (510Vrms with HV option)  
>100Hz: maximum rms voltage follows  $V \cdot f < 46000$   
Frequency: 10 to 400Hz

### Current Mode (CC)

Range: from 0 to ± 200%<sup>(8)</sup> of I<sub>rated</sub> (see models table)  
Setpoint Resolution: 10mA<sub>rms</sub>  
Effective Resolution<sup>(2)</sup>: < 0.05% of FS<sup>(3)</sup> (< 0.1% models 7.5 & 10)  
Setpoint Accuracy<sup>(4)</sup>: < ± 0.2% of FS<sup>(3)</sup>  
Transient Time<sup>(5)</sup>: < 1.5ms (10% to 90% at a step transient)  
Ripple<sup>(7)</sup> (peak-peak): < 0.7% of FS<sup>(3)</sup> (with Low Ripple Inductor option)

### Phase Angle (cos φ)

Range: -90 to 90° in Sink / Source  
Resolution: 0.01°

Enhanced

### Harmonics

Range: up to 50th  
50 independent harmonics per phase:  
20 free programmable frequency and phase from 0.1 to 50 times f<sub>0</sub>  
30 fixed frequency  
Harmonics content:  $V \cdot f < 46000$  (with current derating)  
Setpoint Accuracy<sup>(4)</sup>: same as current accuracy  
Small Signal Bandwidth: up to 5000Hz<sup>(9)</sup>  
Transient Time<sup>(5)</sup>: < 2ms (10% to 90% at a step change)

### Power Mode (CP / CS)

Range: from 0 to ± 200%<sup>(8)</sup> of P<sub>rated</sub> (see models table)  
Derived current setpoint: calculated from ISI and φ(S)  
Setpoint Resolution: 1W, 1VA  
Effective Resolution<sup>(2)</sup>: < 0.1% of FS<sup>(3)</sup> (< 0.25% models 7.5 & 10)  
Setpoint Accuracy<sup>(4)</sup>: ± 0.4% of FS<sup>(3)</sup>  
Transient Time<sup>(5)</sup>: < 2.5ms (10% to 90% at a step to P<sub>rated</sub>)

---

Enhanced

### Impedance Mode (CZ)

Calculation method configurable (rms, instantaneous)  
 Range: from 0.8 to 1000 Ohm, 0.1 to 2000mH, 0 to 3.7mF  
 Derived current/phase setpoint: calculated from  $|Z|$  and  $\phi(Z)$   
 Setpoint Resolution: 0.01 Ohm/mH/mF  
 Setpoint Accuracy<sup>(4)</sup>: see current accuracy  
 Transient Time<sup>(5)</sup>: < 2.5ms (10% to 90% at a step to  $R_{rated}$ )

## Operation Modes

### AC

Programmable Current (CC)  
 Programmable Power (CP / CS)  
 Programmable Impedance (CZ)  
 Steps

## Overload/Overcurrent

Admissible AC overcurrent: 125% of rated value during 10 minutes, 150% during 1 minute, 200% during 2 seconds  
 Admissible overloads: 125% of rated value during 10 minutes, 150% during 1 minute, 200% during 2 seconds

## User Interface

### Local Control (4.3" Touchscreen panel)

Isolated Digital port: 6 inputs, 4 outputs  
 Isolated Analogue port: 6 inputs (rms setpoints or power amplifier), 6 outputs (rms readback or real-time readback)  
 Interlock port: 1 NC Input, 1 NO Output  
 Emergency Stop pushbutton

Emergency Stop pushbutton

Touchscreen panel

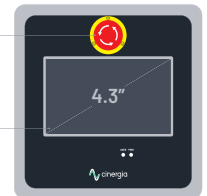

### Remote Control Port

LAN Ethernet with Open Modbus-TCP protocol  
 RS485 (option), CAN and RS232 (using external gateway)

### Software

Graphical User Interface for Windows 7/10  
 LabView drivers and open Labview interface example

Enhanced

### Master/Slave Operation

Connection: fiber optics link (x6)  
 Configuration: from software user interface/MODBUS up to 8 units:  
 AC: Parallel  
 DC: Parallel, serial or serial-parallel

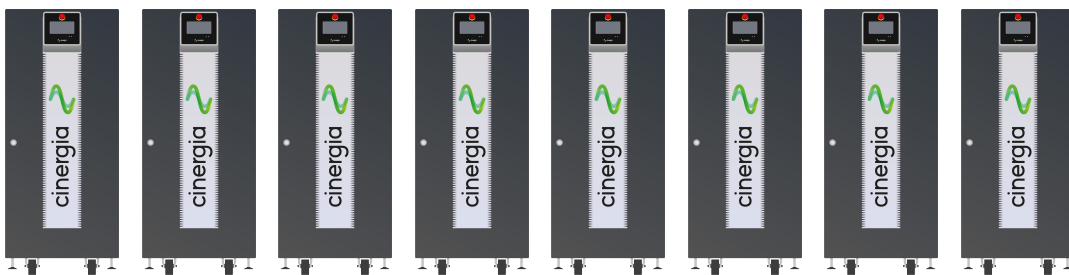

## Size and Weight

### Models 7.5 to 60 kW

#### Height

1100 mm

#### Width

450 mm

#### Depth

770 mm

#### Weight

200 kg

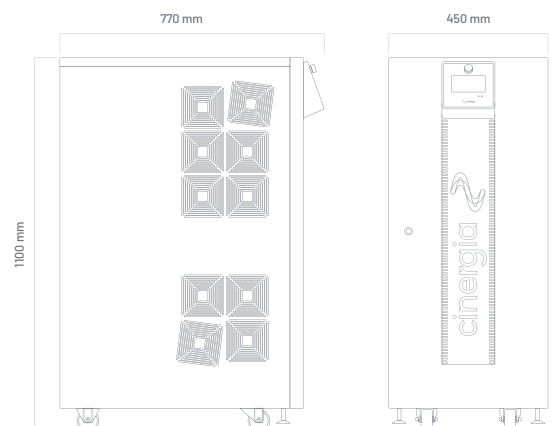

### Models 80 to 120 kW

**Height**

1320 mm

**Width**

875 mm

**Depth**

870 mm

**Weight**

400 kg

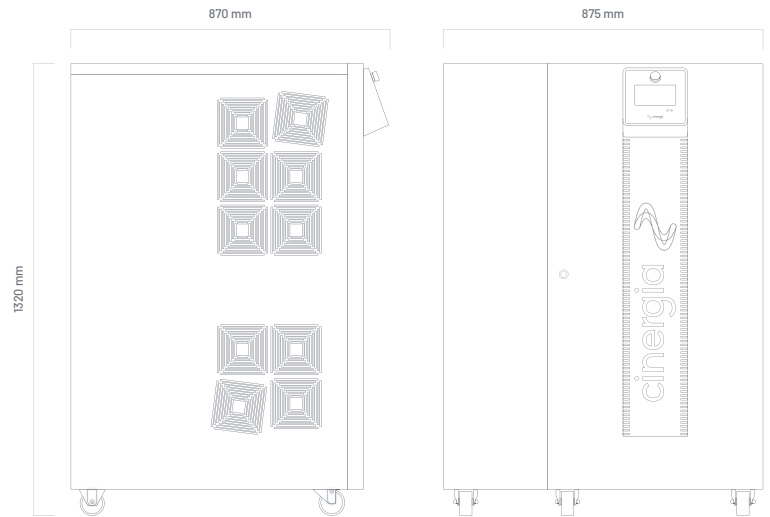

### Models 160 & 200 kW

**Height**

2000 mm

**Width**

900 mm

**Depth**

850 mm

**Weight**

680 kg

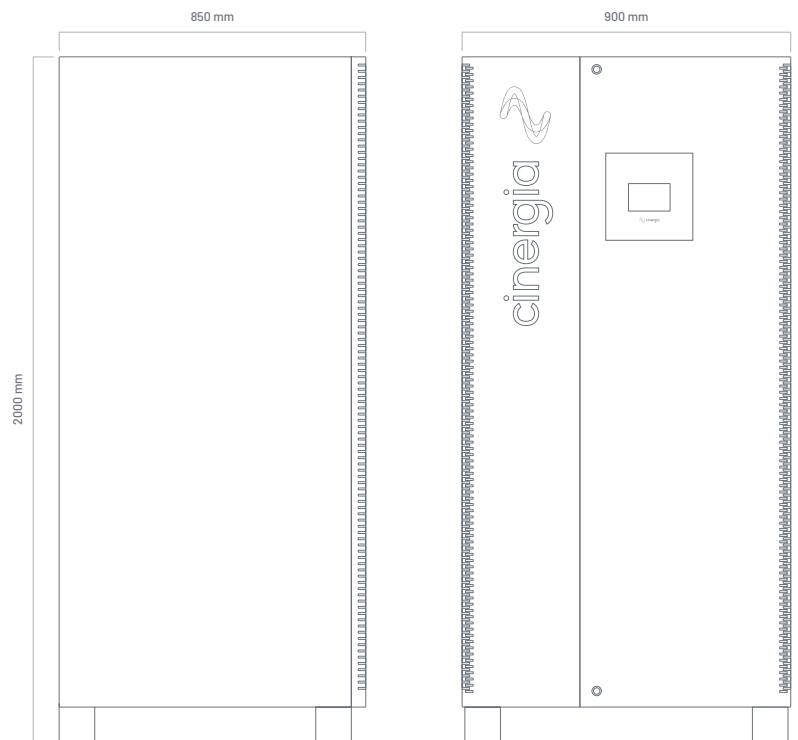

## Connections

Fiber Optics

Digital IO

EPO EPO Output

Analogue IO

Internal Comms

Modbus

CAN Out

RS323 / RS485

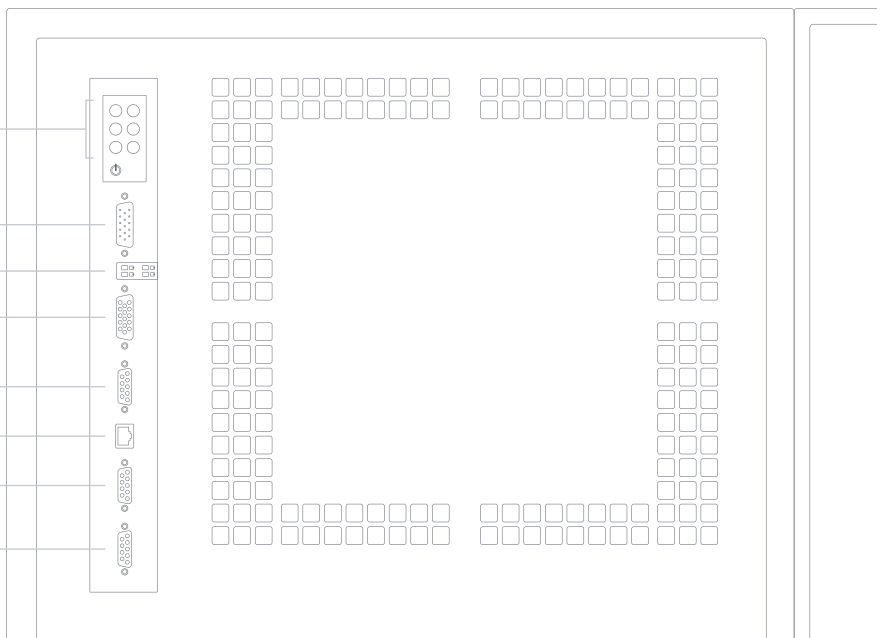

The distribution of the connectors may change depending on the models

## Selectors

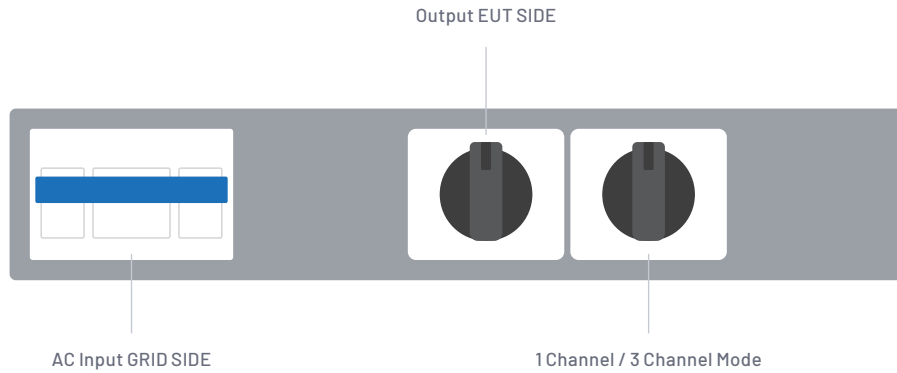

The type of selectors and their location may change depending on the models

## Protections

Overvoltage (peak, rms), Overcurrent (peak, rms), Overload  
Shortcircuit, Emergency Stop, Watchdog, Heart Beat, Output  
Contactor, Wrong Configuration  
Alarms and Limits are user configurable and can be saved in a  
password protected EEPROM

## Mesurements <sup>(6)</sup>

Grid Voltage (rms), Current (rms), Power (P,O) and Frequency  
Output Voltage (rms, avg), Current (rms, avg), Power (P,O) and Frequency  
Heatsink Temperatures (x2) and DC Link Voltage  
Datalogging available through FTP connection

## Ambient

Operating temperature<sup>(8)</sup>: 5-40°C  
Relative Humidity: up to 95%, non-condensing  
Cooling: Forced air  
Acoustic noise at 1m: < 52dB(A)(7.5 to 60), < 65dB(A)(80 to 120), < 70dB(A)(160 and 200)

## Standards

CE Marking  
Operation and Safety: EN-50178, EN-62040-1  
EMC: EN-62040-2  
RoHS

All specifications are subject to change without notice.

## Options

Choose your options:

- Galvanic Isolation
- Three channel mode: allows different operation mode start/stop/reset per channel (included in all models from 7.5 to 60, both included)
- 30kHz Switching Frequency: only available for models 15 (derated to 7.5kW), 20 (derated to 7.5kW) and 30 (derated to 10kW)
- Isolation monitor (advised for IT systems)
- Low current ripple inductance (included in all models ≤54kW. optional for models ≥80kW)
- High Frequency 360 - 900Hz
- Anti-islanding monitor (only advised in net injection to the grid and following local regulations)
- High Voltage (HV): voltage up to 295Vrms phase-neutral in AC up to 800V in DC
- RS485

All specifications are subject to change without notice.

1. Minimum voltage setpoint is 0V in DC. The recommended minimum setpoint for long-term use is 20Vrms in AC and 20V in DC.
2. Effective resolution measured with a 400ms window
3. FS Range of voltage is 830V (with High Voltage option)  
FS Range of current is  $2 \cdot |3 \cdot I_{rated}|$  (see models table)  
FS Range of power is  $2 \cdot |200\% \cdot Prated|$  (see models table)
4. Accuracies are valid for settings above 10% of FS
5. Measured with the rated resistive load and high-dynamics controllers configuration.
6. Accuracy of measurements is  $\pm 0.1\%$  of FS for rms voltage,  $\pm 0.2\%$  of FS for rms current,  $\pm 0.4\%$  of FS for active power (valid only above 10% of FS)
7. Consult us for lower voltage/current ripple requirements
8. Rated power figures are given at 20°C
9. The maximum output voltage depends on frequency following  $V \cdot f < 46000$
10. With fast DC control behaviour



# Models

## EL+ vAC

Reference	AC Power Rated <sup>(9)</sup>	AC Current Rated <sup>(9)</sup> RMS 3 channels / 1 channel	DC Power Rated <sup>(9)</sup>	DC Current Rated <sup>(9)</sup> RMS 3 channels / 1 channel	Weight (kg)	Dimensions DxWxH (mm)
EL+7.5 vAC	7.5 kW	11 A / 33A	-	-	155 kg	770 x 450 x 1100 mm
EL+10 vAC	10 kW	15 A / 45 A	-	-	155 kg	770 x 450 x 1100 mm
EL+15 vAC	15 kW	22 A / 66 A	-	-	155 kg	770 x 450 x 1100 mm
EL+20 vAC	20 kW	29 A / 87 A	-	-	155 kg	770 x 450 x 1100 mm
EL+30 vAC	27 kW	40 A / 120 A	-	-	155 kg	770 x 450 x 1100 mm
EL+40 vAC	40 kW	58 A / 174 A	-	-	200 kg	770 x 450 x 1100 mm
EL+50 vAC	50 kW	73 A / 219 A	-	-	200 kg	770 x 450 x 1100 mm
EL+60 vAC	54 kW	80 A / 240 A	-	-	200 kg	770 x 450 x 1100 mm
EL+80 vAC	80 kW	116 A / -	-	-	400 kg	870 x 875 x 1320 mm
EL+100 vAC	100 kW	145 A / -	-	-	400 kg	870 x 875 x 1320 mm
EL+120 vAC	108 kW	157 A / -	-	-	400 kg	870 x 875 x 1320 mm
EL+160 vAC	145 kW	211 A / -	-	-	680 kg	850 x 900 x 2000 mm
EL+200 vAC	160 kW	232 A / -	-	-	680 kg	850 x 900 x 2000 mm

All specifications are subject to change without notice.

For EL mode is not available a physical 3 channel/1 channel switch. To work in a single phase mode, it's necessary to introduce a monophasic grid at the output.

## Galvanic Isolation (optional)

	Circuit Breaker Recommended	Weight	
Inside the cabinet	IT 7.5i	Type C - 25 A	145 kg
	IT 10i	Type C - 25 A	145 kg
	IT 15i	Type C - 32 A	145 kg
	IT 20i	Type C - 40 A	145 kg
	IT 30i	Type C - 50 A	195 kg
	IT 40i*	Type C - 63 A	195 kg
	IT 50i*	Type C - 83 A	195 kg

\*In the IT 40i and IT 50i models the size of the cabinet increases to a total of 770 x 835 x 1100 mm. The others keep the original size.

	Circuit Breaker Recommended	Weight	Dimensions D x W x H	
In external cabinet (IP20)	IT 30e	Type D - 80 A	174 kg	595 x 415 x 708 mm
	IT 40e	Type D - 100 A	217 kg	725 x 525 x 773 mm
	IT 50e	Type D - 125 A	280 kg	725 x 525 x 773 mm
	IT 60e	Type D - 160 A	381 kg	875 x 600 x 900 mm
	IT 80e	Type D - 200 A	435 kg	875 x 600 x 900 mm
	IT 100e	Type D - 250 A	458 kg	875 x 600 x 900 mm
	IT 120e	Type D - 315 A	514 kg	875 x 600 x 900 mm
	IT 160e	Type D - 400 A	612 kg	964 x 648 x 1252 mm
	IT 200e	Type D - 500 A	753 kg	1192 x 744 x 1430 mm

## Configuration Modes

EL+ AC

PHIL AC

## Master / Slave

Parallel

in AC modes (GE & EL)

## Channel Configuration in EL

3 channels

\* 1 channel

\*For 1-channel configuration contact us.

# Regenerative Power Electronic Solutions



Can Baletes 7, Nau A  
08310 Argentona  
Barcelona (Spain)  
+34 934 864 358  
cinergia@ciner giapower.com

Follow us on:  
Youtube, LinkedIn, Twitter